

SenseTek B.V.

Abberdaan 162
1046 AB, Amsterdam, Nederland

Tel: +31(0)20 6 13 16 11
Fax: +31(0)20 6 13 22 12
Web: www.sensetek.nl

27.6 Vdc Switch Mode Power Supply for Fire – EN54-4

STX2410-E Optional BATT-BOX-65

STX2410-H

FEATURES

The STX2410-x is an EN54-4 approved power supply ideal for use in Fire control Systems. Its regulated 27.6V dc output will supply a total of 10 Amps continuous into the load, whilst also enabling battery charging. (7.2 Amps Load with 65Ah batteries, 10 Amps with 18Ah batteries). The power supply output features electronic short circuit protection under both mains and standby battery operation.

Maximum battery life is assured through continuous active battery monitoring and the use of a three stage charger, comprising bulk, absorb and temperature compensated final float phase depending upon battery condition. Once fully charged the product operates in Eco power saving mode, whereby it will check and top up battery charge every 2 hours, but will not waste energy by continuously attempting to charge a fully charged battery. This also extends the operating life of the battery. Deep discharge protection prevents premature battery failure when operating from standby for extended periods. Two sets of volt free solid state relay fault output signal (i) loss of mains and (ii) battery fault, charger fault and loss of output. In addition there is an RS232 serial interface that can provide diagnostic and fault reporting information to supervisory systems.

- Certified by UL to EN54-4:1997 +A1: 2002 + A2: 2006.
- Up to 10 A current to load at 27.6V dc nominal regulated output.
- Charging capability to support 18, 38 or 65Ah batteries with intelligent load enhancement.
- Electronic overload protection shuts down output until overload or short circuit is removed.
- Battery Monitor detects battery missing, low battery, short-circuit or reverse connection.
- Battery charging circuit is energised only when a battery is correctly connected and the battery voltage is greater than 14 V.
- No loss of output during automatic connection of battery to load on loss of mains.
- Deep discharge protection disconnects battery from load when battery voltage falls to 21 V.
- Fault indicator LED (Yellow) flashes on detection of output fault, battery fault, charger fault and mains failure.
- Mains indicator LED (Green) showing mains present.
- RS232 serial interface for fault reporting and diagnostics interface to OEM equipment.

SPECIFICATION

Mains Input

Rated Voltage	110 – 240V ac
Frequency	49 – 61 Hz
Input current	< 4.0 Amps at full load
Inrush current	30 A Max at 25 °C 110V ac for 10 ms
Fuse	T4.0 A, 20 mm, 250V ac HRC

Output

Battery mode selected	18 Ah	38 Ah	65 Ah
Voltage at full load			
Mains power	26.0 – 28.5 Vdc (range) (27.6 V nominal)		
Battery standby	18 – 26.0 Vdc		
Ripple	<100 mV pk – pk max @ Rated Voltage		
Fuse			
Load	F10.0 A		
Battery	F10.0 A		
Overload	Electronic shutdown at 15 A until overload or short circuit removed		
Continuous Output Current			
No charging (Imax B)	10.0 A	10.0 A	10.0 A
With charging (Imax A) – 220V	10.0 A	8.0 A	7.2 A
With charging (Imax A) – 110V	8.5 A	7.5 A	6.5 A
Battery Capacity	2 x 17Ah 12 V	2 x 38 Ah 12 V	2 x 65 Ah 12 V
eg			
- PowerSonic model	PS12170	PS12380	PS12650
- Yuasa model	NP17-12I	NP38-12I	NP65-12I
- Interlogix model	BS131N		BS133N
Battery Charging	Constant current bulk charging to 80% capacity within 24 hours Float charging to 100% within 48 hours Eco charging and check every 2 hours – (for 20 minutes)		
Constant current charge	0.7 A	1.6 A	2.6 A
Low battery threshold voltage	23 V		
Deep discharge protection	Threshold voltage – 21 V		
Quiescent current – no load	30 mA		
Quiescent current – batt cut off	0 mA		

Mechanical

Product Reference	STX2410-E	STX2410-H	BATT-BOX-65
Enclosure Dimensions w x h x d (mm)	400 x 420 x 80	420 x 420 x 180	450 x 535 x 245
Weight (kg) excluding battery	6.4	9.7	12.9
Material	1.2mm steel white powder coated		

Environmental

Temperature – Operating	-10 to +40°C (operating) 75% RH non-condensing
Temperature - Storage	-20 to +80°C (storage)

CONNECTIONS

Load Output ++ / --	Screw terminals Voltage output to load
GEN PSU Fault (normally closed contact)	0.10 A @ 60 V dc 16Ω solid state relay contacts, volt free Open if Mains failed and battery voltage < 23V or fault PSU fault condition, (see below)
EPS Fault (normally closed contact)	0.10 A @ 60 V dc 16Ω solid state relay contacts, volt free Open if loss of mains for > 10 seconds
Temperature sensor	Thermistor input from supplied battery terminal thermistor.
BATT + / -	Connection to back up battery using supplied battery lead
FAN + / -	Not used
RS232 serial interface	4 pin header

SIGNALLING AND DIAGNOSTICS

Fault Outputs

EPS Fault	GEN Fault	Condition	Possible Cause	Action
CLOSED	CLOSED	Normal operation	Mains present Battery healthy	None
OPEN	CLOSED	Standby Mode	Mains lost Battery driving load	Investigate loss of mains
CLOSED	OPEN	Fault Present	Blown fuses Battery fault Overload Internal fault	Investigate fault source using diagnostic LED Rectify fault where possible
OPEN	OPEN	PSU Shutdown	Mains lost Standby battery exhausted	Restore mains as soon as possible

LED Indication

YELLOW LED	Fault LED
GREEN LED	Mains supply On
DIAGNOSTICS	Diagnostic LED (Not visible through front panel)

Fault Diagnostic table – Front panel - User

Yellow LED Fault	Green LED Mains	Condition	Possible Cause	Action
OFF	ON	Normal operation	Mains present Battery healthy	None
FLASH CONTINUOUS	ON or OFF	Fault	Blown fuses Battery fault Overload Internal fault	Contact service engineer
1 PULSE	OFF	Standby Mode	Mains lost Battery driving load	Investigate loss of mains

Fault Diagnostic table – Internal - Engineer

Orange LED Diagnostic	Green LED Mains	Condition	Possible Cause	Action
OFF	ON	Normal operation	Mains present Battery fully charged	None
	OFF	Standby Operation	Mains Lost. No faults present Battery driving load	Investigate loss of mains
FLASH CONTINUOUS	ON or OFF	No output	Output fuse blown Output overload Output short circuit	Check and replace output fuse Disconnect output load and test load
1 PULSE	ON	Battery Charging	No faults active Battery charging normally but < 90% of full charge	None
2 PULSES	ON	No Battery	Battery disconnected Battery fuse blown Battery heavily discharged	Check battery connections Check battery fuse Check battery condition Replace battery if aged
	OFF	Low Battery Volts	Standby Mode Battery almost discharged	Restore mains
3 PULSES	ON or OFF	Battery Fault	High impedance in battery connection Battery internal fault	Check battery connections for corrosion. Replace battery if aged
4 PULSES	ON or OFF	Charger Fault	Internal failure of battery charger	Return to manufacturer
5 PULSES	ON or OFF	Battery Temperature Probe Fault	Battery temperature monitor disconnected or damaged PSU running in Safe Mode	Check temperature sensor connections and condition of sensor. Replace if suspect
ON CONTINUOUS	ON or OFF	Internal Fault	Software fault detected PSU running in Safe Mode	Return to manufacturer

INSTALLATION

This unit is only suitable for installation as permanently connected equipment. The PSU is NOT SUITABLE for external installation. This product (PSE) is designed for the use in automatic fire detection and fire alarm systems. If it is used as power supply equipment for control and indicating equipment, the PSE shall be installed no further than 10cm from the CIE, and close coupled by conduit.

This unit must be fed from a mains power source having a separate (approved) disconnect device and fitted with a fuse or other over-current protection device rated at 5 A maximum. Ensure that the disconnect device used has appropriate earth fault protection to the applicable standard.

Where the PSU is used to provide power to a fire alarm circuit, the mains isolation and disconnect device should be provided solely for this purpose and be suitably marked "FIRE ALARM – DO NOT TURN OFF". All cabling should meet national and local fire system installation regulations, e.g. FP200 type cable for high integrity installations.

Where the PSU is used for other applications, it should be installed according to all relevant safety regulations applicable to that application.

Where the PSU Fault and EPS Fault outputs are used, they should only be connected to circuits having voltages less than 60 Vdc.

Cable Sizing

- 1) Mains input cable must be to the applicable standard with a 5 A or greater current capacity, i.e. 0.75 mm² nominal conductor area, having a minimum operating voltage of 300/500 Vac.
- 2) The low voltage output cable must be sized to carry the rated load current to the devices connected to the PSU.
- 3) Mains input and low voltage output cables should be routed to use different entry / exit holes in the case. Bushes should be used to protect cable sheaths from chafing. Ensure that these bushes are correctly sized (i.e. close fitting with respect to cable sizing). Note that the bushes should meet a minimum flammability specification of UL94 HB.
- 4) All cabling should be securely fastened in position using a cable tie through the saddles provided.

Mounting – E box – 17 Ah

- 5) The E box is designed to support two 17Ah batteries and as such weighs a total of 19.5 Kg when loaded. Ensure that wall fixings are appropriate to support this weight.
- 6) The product should be mounted no further than 10 cm from the control and indicating equipment, close coupled by conduit if it is being used to power the CIE directly.
- 7) Fix to wall or other support structure in correct orientation i.e. with hinge on left hand side, using screws of sufficient size and length through the mounting holes.
- 8) Protect the battery terminals from any metal surfaces during installation as shorting of the terminals is extremely hazardous.
- 9) Knock-outs are provided in the case for mating with external trunking or conduit.
- 10) Ensure that all unused holes (on the rear of the case) are sealed to prevent the ingress of damp and dust.

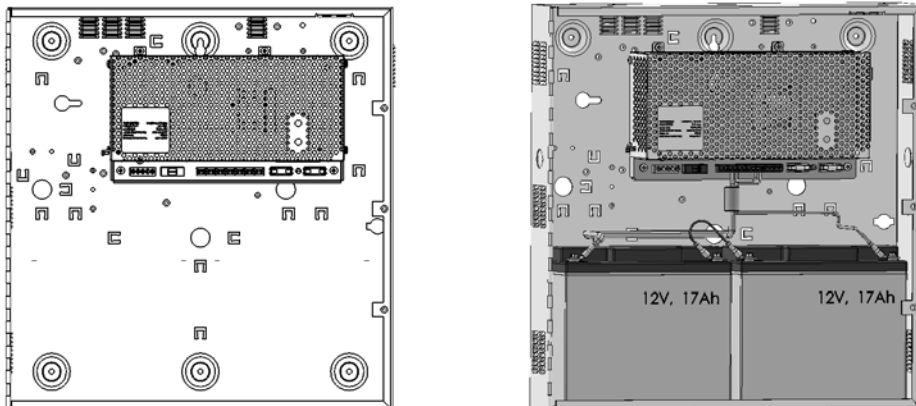

Figure 1 – E Box and Battery mounting

Mounting – BATT- BOX – 65 Ah

- 11) The Battery box is used for 65 Ah batteries is designed to be floor mounted. DO NOT suspend from a wall.
- 12) It is important that the battery box and the PSU are co-located as shown, and connected using the provided extended 3 metre cable.
- 13) A fixing bracket is provided to secure the Battery Box to the wall to prevent it moving away from the wall.

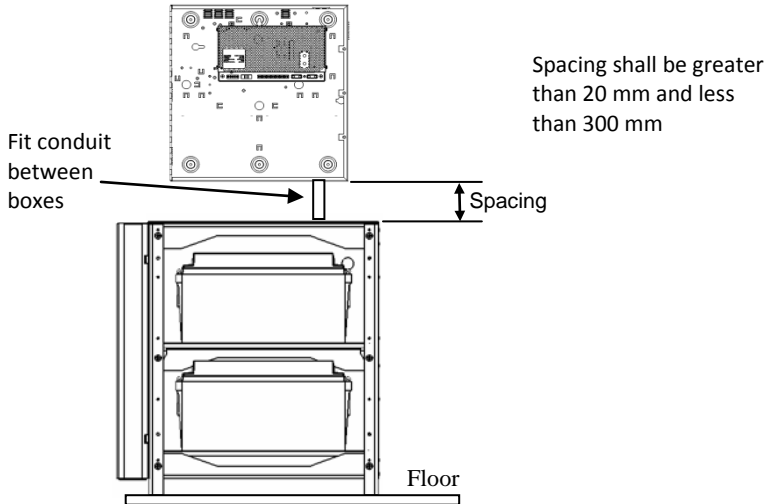

Figure 2 – E Box and Battery box mounting

Mounting – H Box – 38 Ah

- 14) The H box is designed to handle and support two 38 Ah batteries and as such weighs a total of approximately 40 Kg when loaded. Ensure that wall fixings are appropriate and designed to support this weight.
- 15) The product should be mounted no further than 10 cm from the control and indicating equipment, close coupled by conduit if it is being used to power the CIE directly.
- 16) Fix to wall or other structure in correct orientation i.e. with hinge on left hand side, using screws of sufficient size and length through the mounting holes.
- 17) Protect the battery terminals from any metal surfaces during installation as shorting of the terminals is extremely hazardous.
- 18) Knock-outs are provided in the case for mating with external trunking or conduit.
- 19) Ensure that all unused holes (on the rear of the case) are sealed to prevent the ingress of damp and dust.

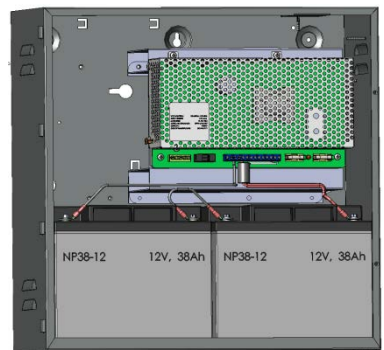
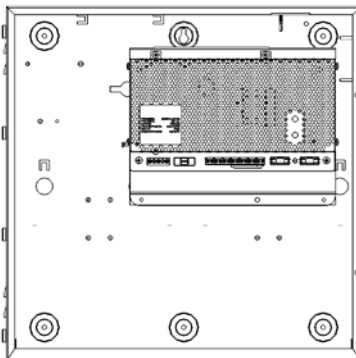

Figure 3 – H Box and Battery box mounting

COMMISSIONING

Mains Power Up

- 1) With no external connections made to the PSU, connect the mains input wires to the terminal block, **ensuring that the mains isolator (disconnect device) is open**. Fasten wiring in place with cable tie to saddle. **Note: Equipment must be earthed.**
- 2) Apply mains input. Ensure that the green Mains LED illuminates and that the red Fault LED flashes after approximately 20s (indicating a disconnected battery).
- 3) Disconnect the mains power.

Load Output and Remote Signalling

- 4) Connect the EPS and PSU Fault outputs to the appropriate inputs of control equipment if remote fault monitoring is required.

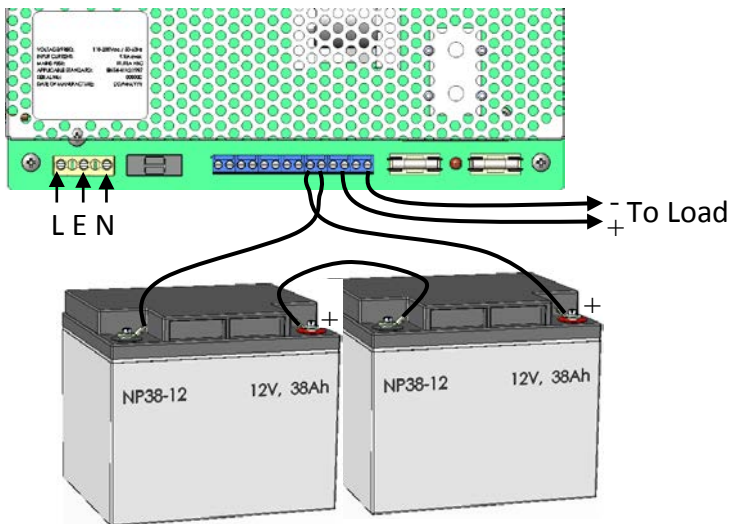

Figure 4 – Power, Load and Battery connections

- 5) Connect the load (output) wiring as shown in Figure 4. Cable tie to saddle provided (adjacent to exit hole).
- 6) Re-apply mains. Verify that the green Mains LED illuminates and the red Fault LED flashes after approximately 20 s (disconnected battery).
- 7) If connected, verify that the EPS Fault monitor shows a *closed* contact and the PSU Fault monitor shows an *open* contact.
- 8) Perform a full functional test of system including full alarm condition.
- 9) Disconnect the mains supply.

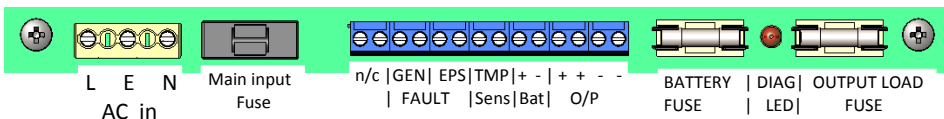

Figure 5 – Terminal labels

Standby Battery

- 10) Select the Battery type by placing the link (above the Battery fuse) in the appropriate location to select (17/18 Ah, 38 Ah or 65 Ah) batteries. This changes the maximum bulk charge current, and therefore enables higher load current to be used when smaller batteries are required. Put the link on the left hand two pins for 17 Ah, the middle pins for 38 Ah and the right hand two pins for 65 Ah batteries.

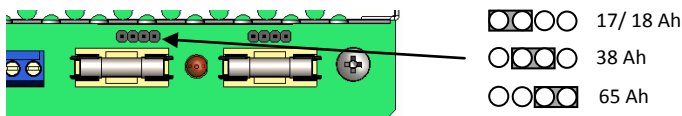

Figure 6 – Standby battery size selection links

- 11) Mount the appropriate batteries as shown above. Where a dual box solution is used all cabling between the two boxes should be routed to use separate case entry/exit holes from other cabling and use suitable bushes to protect the cables.
- 12) Connect the two 12 V standby batteries in series using the single cable provided. Connect the *negative* of one battery to the *positive* of the other. **DO NOT CONNECT** the other two battery terminals to each other.
- 13) Connect the free Positive and Negative terminals of the batteries to the PCB terminals Batt+ and Batt - using the cables provided. See Figures 4 & 5.
- 14) Connect the battery temperature sensor (two white wires) to the PCB terminals TMP Sens. See Figure 5.
- 15) If the batteries are housed remotely, replace the battery lead assembly (including battery temperature sensor) with an extended length assembly, provided with the Battery box (Ensure the temperature sensor and battery connections are made according to figure 5).
- 16) Verify that the red Fault LED stops flashing after about 20 s (battery connection detected). Verify that the remote GEN PSU Fault monitor shows a *closed* contact.
- 17) Disconnect the mains power. Verify that the green Mains LED extinguishes and the red Fault LED starts to pulse (indicating that the PSU is running from its standby batteries).
- 18) If connected, verify that the EPS Fault monitor shows an *open* contact and the PSU Fault monitor shows a *closed* contact.
- 19) Perform a full functional test of system including full alarm condition. Verify that the standby batteries can support the system load. Note: ensure batteries have sufficient charge.

Final

- 20) Reconnect the mains. Verify that the green Mains LED illuminates and the red Fault LED extinguishes.
- 21) If connected, verify that the EPS Fault monitor shows a *closed* contact and the GEN PSU Fault monitor shows a *closed* contact.
- 22) Close cover and secure using fastening screws provided.

OPERATING INSTRUCTIONS

In the event of loss of mains, a battery fault or a GEN fault, the corresponding Fault signal contacts will open.

If the output of the PSU fails, the cause of the failure should be investigated e.g. short circuit load, connection of a deeply discharged battery. The fault should be rectified before restoring power to the PSU. If any of the fuses require replacing, ensure the correct fuse rating and type is used.

MAINTENANCE

Maintenance

This unit is intended for use by Service Personnel only. There are NO USER SERVICEABLE parts inside.

There is no regular maintenance required of the PSU other than periodic testing, and replacement of the standby battery. **Reference should be made to the battery manufacturer's documentation to determine typical/expected battery life with a view to periodic replacement of the battery.**

DIAGNOSTICS

Local Diagnostics

Green LED

On = Mains Present

Yellow LED

Fault Diagnostics according to table:

Yellow LED (fault)	Green LED (mains)	Status
OFF	ON	Normal: Battery fully charged
One short flash every second	ON	Normal: Battery charging but not fully charged
Flashing: 1second On 1 second Off	ON	Fault: Output fuse or battery fuse blown, or battery missing
	OFF	Fault: No mains, output fuse blown
One short flash every 3 seconds	OFF	Fault: No mains, battery supplying load.
OFF	OFF	Fault: No mains, No output, Batteries disconnected or completely discharged

COMPLIANCE

This power supply unit meets the essential requirements of the following EU Directives:

CPR:	305/2011 EU
EMC:	2004/108/EC
Low Voltage:	2006/95/EC
WEEE:	2002/96/EC
RoHS:	2011/65/EU



Functional standard:	EN54-4:1997 +A1 +A2 Environmental Class II
Certification Body:	Underwriters Laboratory
Declaration of Performance	DOP2014/04 DOP2014/05

DISPOSAL OF PRODUCT AT END OF LIFE

This product falls within the scope of EU Directives 2002/96/EC Waste Electrical and Electronic Equipment (WEEE) and 2006/66/EC (Battery). At the end of life, the product must be separated from the domestic waste stream and disposed via an appropriate approved WEEE disposal route in accordance with all national and local regulations.

Before disposal of the product, any batteries must be removed, and disposed separately via an appropriate approved battery disposal route in accordance with all national and local regulations. Package used batteries safely for onward transport to your supplier, collection point or disposal facility.

***Caution: Risk of fire or explosion
if bare battery wires are allowed to touch.***

See Specification for battery type information. The battery is marked with the crossed out wheellie bin symbol, which may include lettering to indicate cadmium (Cd), lead (Pb), or mercury (Hg).

For more information see: www.recyclethis.info

*The packaging supplied with this product may be recycled.
Please dispose of packaging accordingly.*