

- DIGITAL ACOUSTICALLY TRIGGERED DOOR HOLDER
- LEARNS THE SOUND OF YOUR FIRE ALARM
- EASY, WIRE FREE INSTALLATION AND PROGRAMMING
- DAILY TIMED RELEASE OPTION
- 200 N HOLDING FORCE
- TWO ALKALINE C CELL BATTERIES
- APPROVED TO EN1155 AND CE MARKED



The Agrippa door holder learns the sound of your specific fire alarm, releasing the door in the event of a fire.

This new innovation in the industry is also wire free, so it can easily be retrofitted to any door. The releasing trigger reacts to a particular sound rather than simply a loud noise, significantly reducing false activations.

The holder is easy to install, only requires C cell batteries (which last for 12 months) and can be programmed for daily release. Suitable for installation to BS 7273-4 category B.

Other features include a seven segment LED display, manual release button and a low battery warning display.

Ideally suited to environments such as care homes, schools and hospitals where it is essential to have doors in an open position at certain times of the day to aid access, but equally as important to ensure the doors are closed in the event of a fire.

The holder is part of the Agrippa suite of products, which also includes an acoustically triggered fire door closer.

TECHNICAL INFORMATION

Holding force	200 N
Power size	5
Default setting	65dBA, 1.2 - 3.0 kHz
Preferred sounder	Continuous tone *
Dimensions	L-118 x W-102 x D-66
Standard finish	White
Other available finishes	Polished brass
Part number	3-80-0062

* Not suitable for voice alarm systems

Patented in the United Kingdom under patent number 2507582

Part Number : 3-80-0060

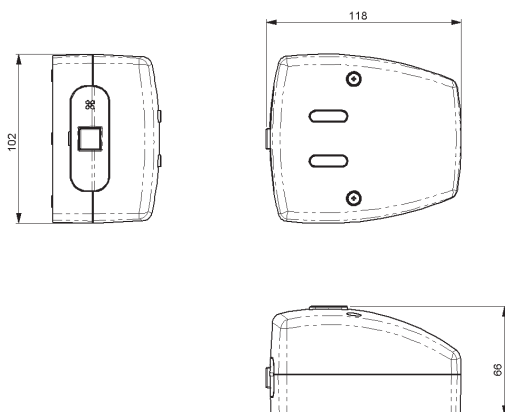

Keeper Plate

